

Versatronik® 505 & 505D
Communication Gateway
BACnet IP



Document Applicable to:
Versatronik 505 NR2/BACIP P/N 704050
Versatronik 505D NR2/BACIP P/N 704069

Applicable Controls
Vitocontrol-S, MW1 and MW2
Vitotronic 300-K, MW1B and MW2B
Vitotronic 100, GC1/GC1B
Vitotronic 300, GW2
Vitotronic 300, GW5B
Vitotronic 200, HO1
Vitodens 200 B2HA

Technical, Installation and Configuration Information

Cautionary Statement

The information presented in this document is only to be used by those familiar with its application and use.



C US LR 102874

IMPORTANT

Read and save these instructions for future reference

About these instructions



Take note of all symbols and notations intended to draw attention to potential hazards or important product information. These include "WARNING", "CAUTION" and "IMPORTANT". See below.



WARNING

Indicates an imminently hazardous situation which, if not avoided, could result in death, serious injury or substantial product/property damage.

→ Warnings draw your attention to the presence of potential hazards or important product information.



CAUTION

Indicates an imminently hazardous situation which, if not avoided, may result in minor injury or product/property damage.

→ Cautions draw your attention to the presence of potential hazards or important product information



CAUTION

Static sensitive components may be damaged by improper handling or work within the control. Ensure all possible measures are taken to eliminate build-up of static electricity.

→ Helpful hints for installation, operation or maintenance which pertains to the product.

IMPORTANT

Trademark Information

Viessmann® and Vitotronic® are trademarks of Viessmann Werke GmbH & Co KG registered in the United States and other countries.

Please visit:

www.viessmann.ca
www.viessmann.us



BACnet® is a registered trademark of the American Society of Heating, Refrigerating and Air-Conditioning Engineers, Inc., 1791 Tullie Circle NE, Atlanta, GA 30329.

For more information please visit:

www.bacnet.org
www.ashrea.org

Important Regulatory and Installation Requirements

Codes

The installation of this unit must be in accordance with local codes.

→ *Please carefully read this manual prior to attempting installation. Any warranty is null and void if these instructions are not followed.*

All electrical wiring is to be done in accordance with the latest edition of CSA C22,1 Part 1 and/ or local codes. In the U.S. use the National Electrical Code ANSI/NFPA 70.

→ *The completeness and functionality of field-supplied electrical controls and components must be verified by those installing the device*

The installing contractor must comply with the Standard of Controls and Safety Devices for Automatically-fired Boilers, ANSI/ASME CSD-1 where required by the authority having jurisdiction.

Working on the equipment

The installation, adjustment, service and maintenance of this unit must be done by a licensed professional heating contractor or persons who are qualified and experienced in the installation, service, and maintenance of similar products. There are no user serviceable parts on this control.

 WARNING
More than one live circuit. See wiring diagram in this manual. Turn off power supply to control and damper/blower before servicing. Contact with live electrical components can result in serious injury or death

Power supply

Install power supply in accordance with the regulation of the authorities having jurisdiction or in absence of such requirements, in accordance with National Codes.

Purpose of Device and Operation

The Versatronik 505 gateway provides a communication translation between applicable controls and DDC systems which are capable of BACnet IP communications.

The Versatronik gateway may be either part of a control panel or stand-alone control device.

This page is intentionally left blank

Installation

Mounting Versatronik Gateway—120VAC Unit

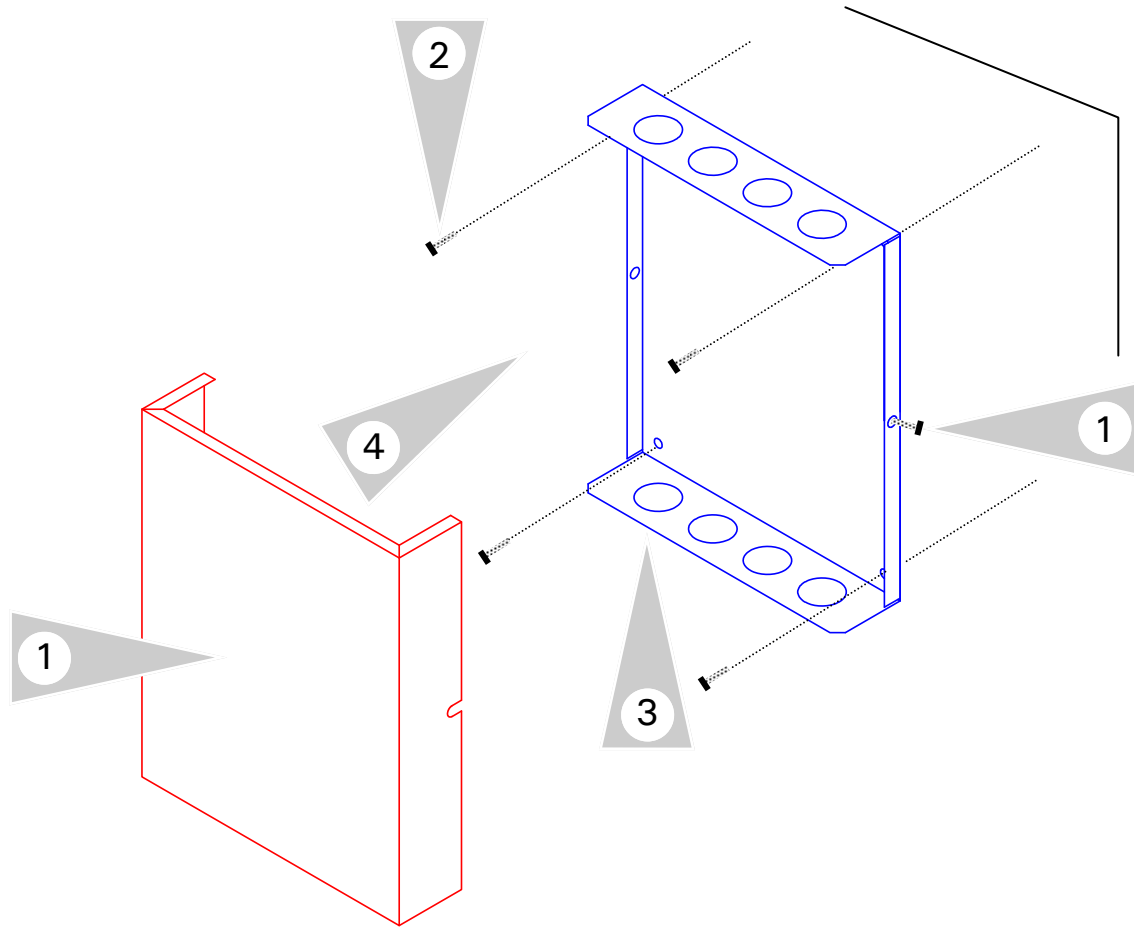

Mounting Steps

1. Mount Versatronik 505 Gateway in a convenient location near the connected boiler controls control. Remove cover by loosening the two screws on either side of base to release the cover.
2. Fasten base to wall using field-supplied screws/fasteners.
3. Remove knockout and installed wire strain relief or box connector. Removal of remaining knockouts is required to make further connections.
4. Once all of the 120VAC and low voltage connections are complete and verified, reinstall the cover from Step 1.



WARNING

When extending wire there is the possibility of exposure to electromagnetic interference. Avoid running wires beside or near high voltage 120/240 VAC conductors. If proximity to high voltage conductors cannot be avoided, use stranded, twisted pair of shield design wire. Ensure that only one end of the shielding is grounded.

Installation

Mounting Versatronik Gateway—24VAC DIN Rail Unit

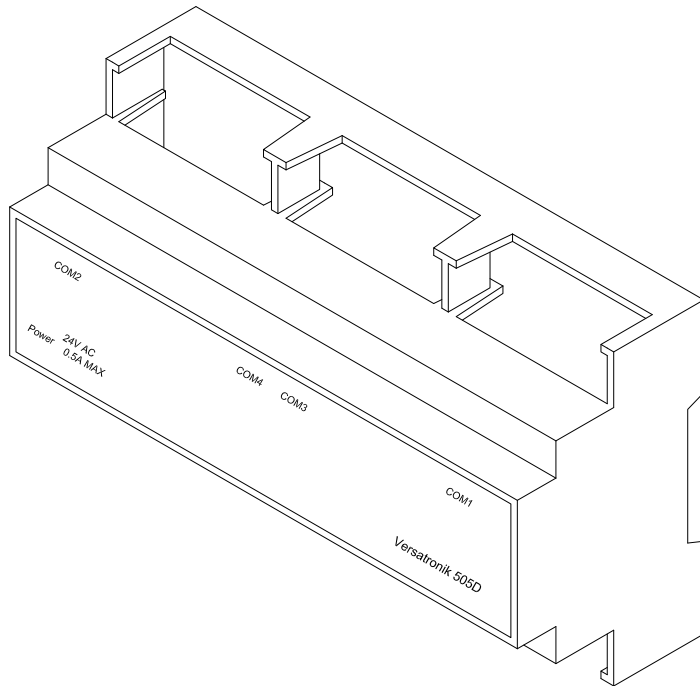

Mounting Steps

1. Mount Versatronik 505D Gateway onto DIN rail within an enclosure in a convenient location near the boiler controls.
2. Make all the necessary connections including the field-supplied 24VAC power connection.



Connection Overview

1. BACnet IP RJ45 connection
2. Control LON Connection RJ45
3. Paralleled BUS Connection
4. 24VAC Power Connection

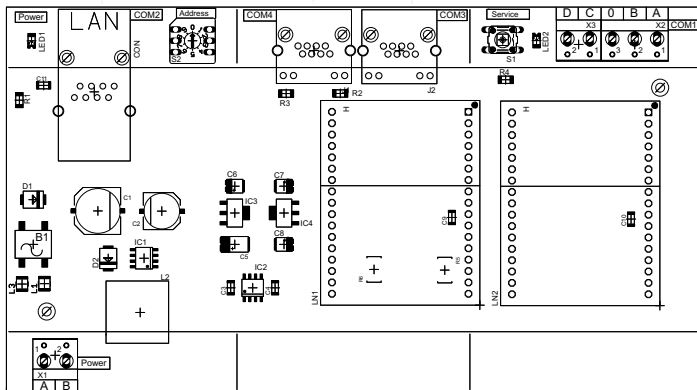

WARNING

When extending wire there is the possibility of exposure to electromagnetic interference. Avoid running wires beside or near high voltage 120/240 VAC conductors. If proximity to high voltage conductors cannot be avoided, use stranded, twisted pair of shield design wire. Ensure that only one end of the shielding is grounded.

Versatronik 505 Dial Setting Overview

Rotary Dial Setting

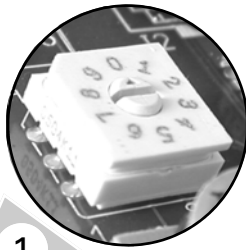

Setting Overview

1. The rotary dial setting on the Versatronik Gateways provides addressing information for systems that may utilize a number of Versatronik Gateways.

It is not required to make adjustments to the rotary dial setting. It should be left in the factory default position setting of 0.

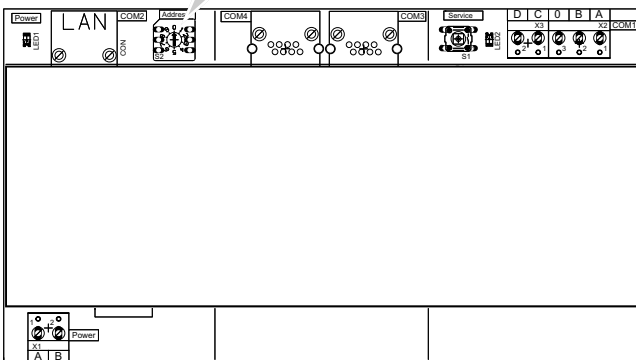
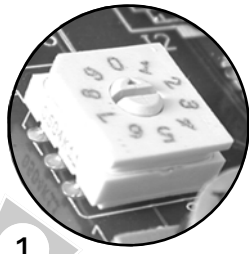
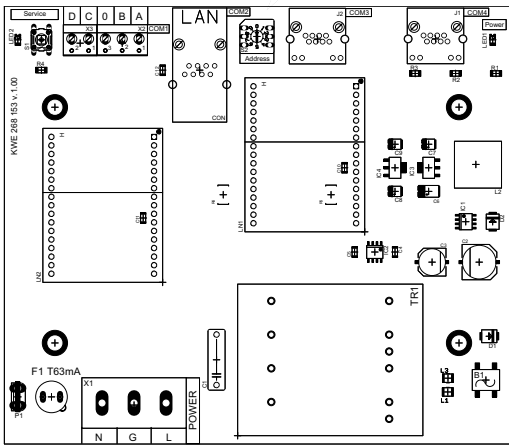

Connection Overview—120VAC

Communication connections—Vitotronic 100, GC1/GC1B, 300 GW2 or 300 GW5B
BACnet IP

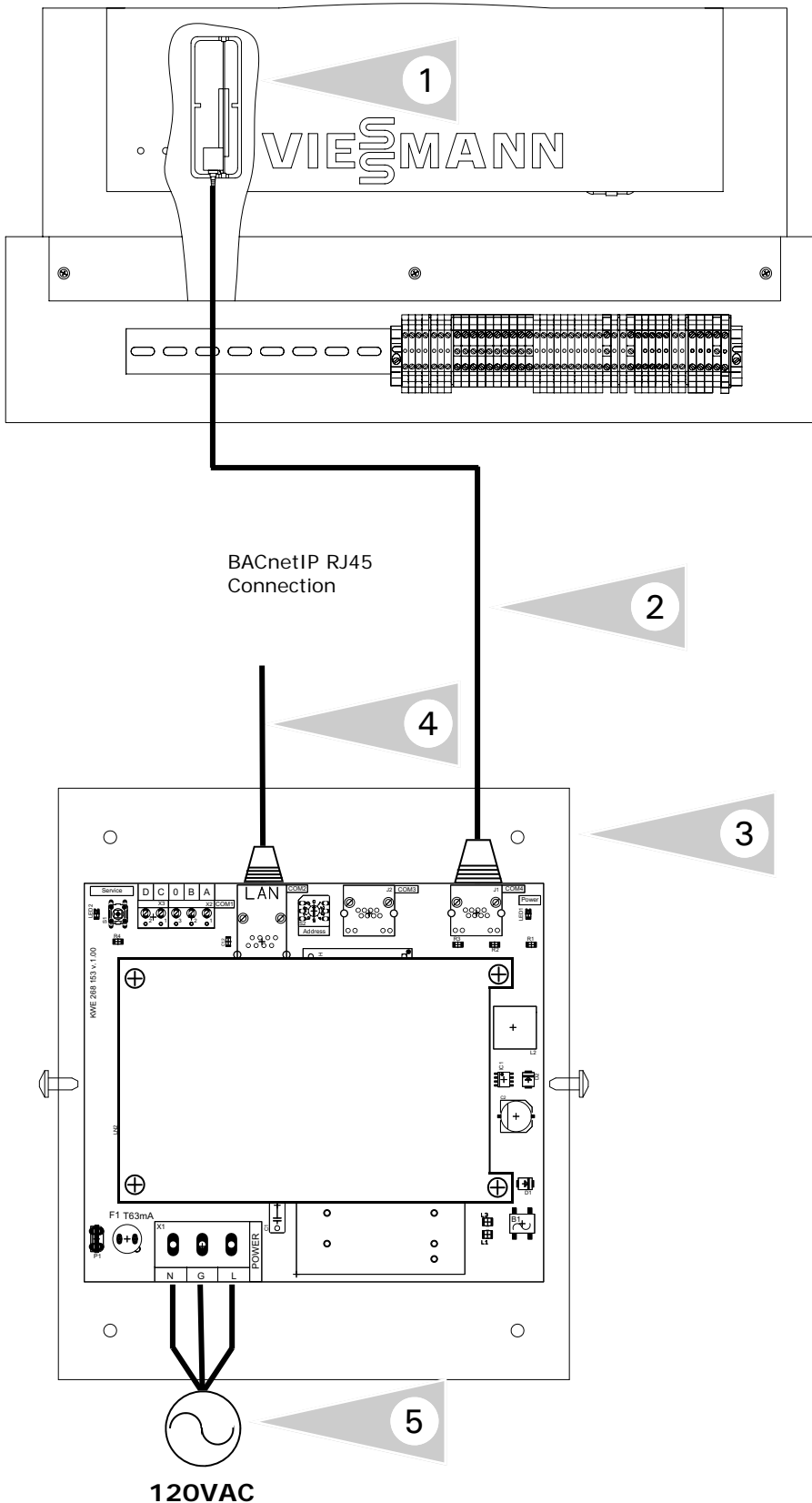

Connection Overview

Refer to manual specific to boiler control. Ensure necessary LON communication card installed.

- 1 Control showing location of LON card and its location within.
- 2 A 3'/91cm CAT-5 cable is supplied with the gateway. The RJ45 is plugged into the control and terminates into the RJ45 socket inside of the Versatronik 505 gateway.
- 3 Versatronik 505 gateway.
- 4 The RJ45 BACnetIP communication connection plugged into Versatronik 505 gateway.
- 5 Plug-in power cord for 120VAC Versatronik 505 gateways.

Connection Overview—24VAC

Communication connections—Vitotronic 100, GC1/GC1B, 300 GW2 or 300 GW5B
BACnet IP

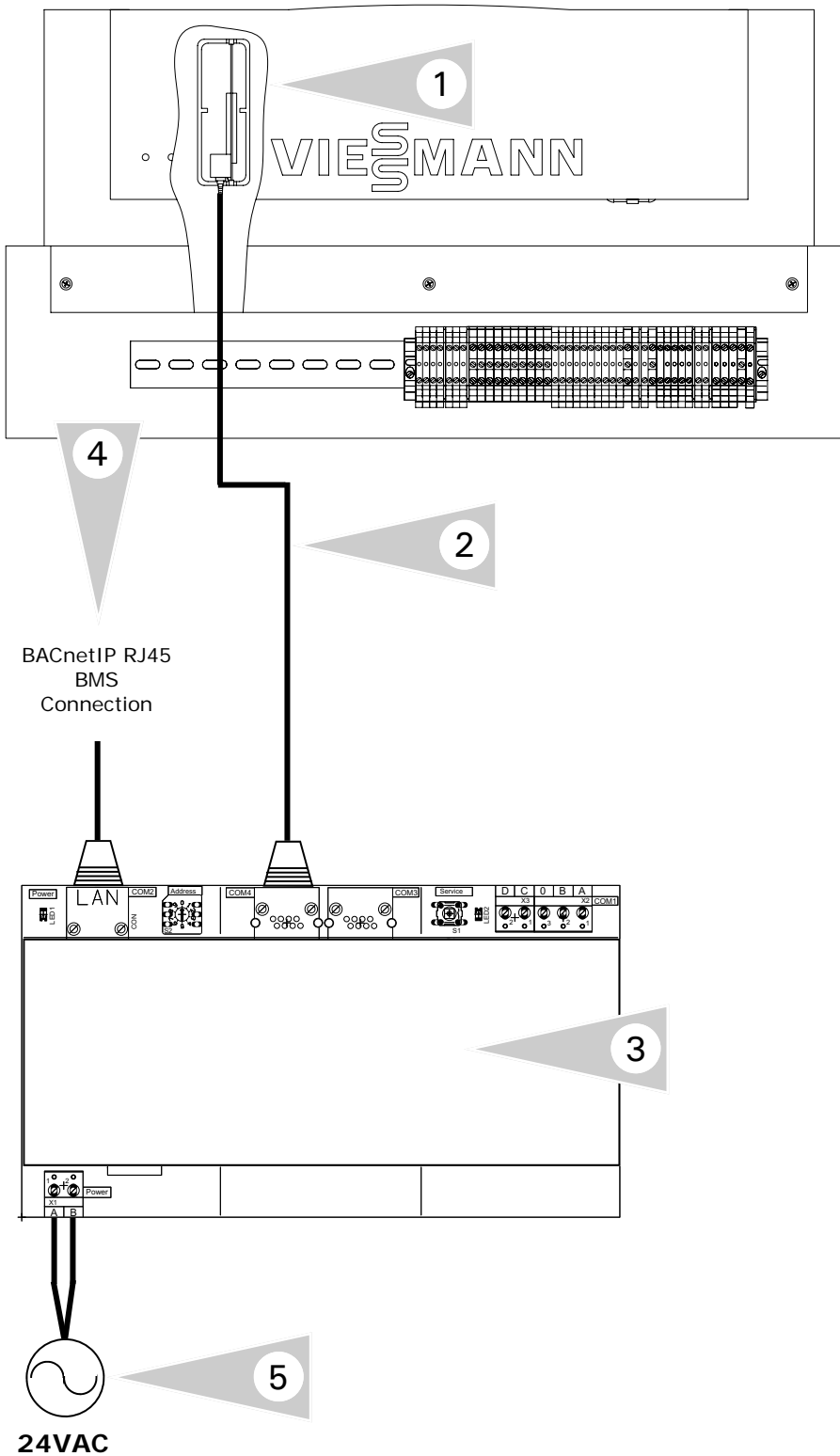

Connection Overview

Refer to manual specific to boiler/system control. Ensure necessary LON communication card installed.

- 1 Control showing location of LON card and its location within.
- 2 A 3'/91cm CAT-5 cable is supplied with the gateway. The RJ45 is plugged into the control and terminates into the RJ45 socket inside of the Versatronik 505 gateway.
- 3 Versatronik 505 gateway.
- 4 The RJ45 BACnetIP communication connection plugged into Versatronik 505 gateway.
- 5 Field-supplied 24VAC power supply for gateway.

Connection Overview—120VAC

Communication connections—Vitocontrol-S, CT3/VD2A or Vitotronic 300-K MW1B
BACnet IP

BACnetIP RJ45
Connection

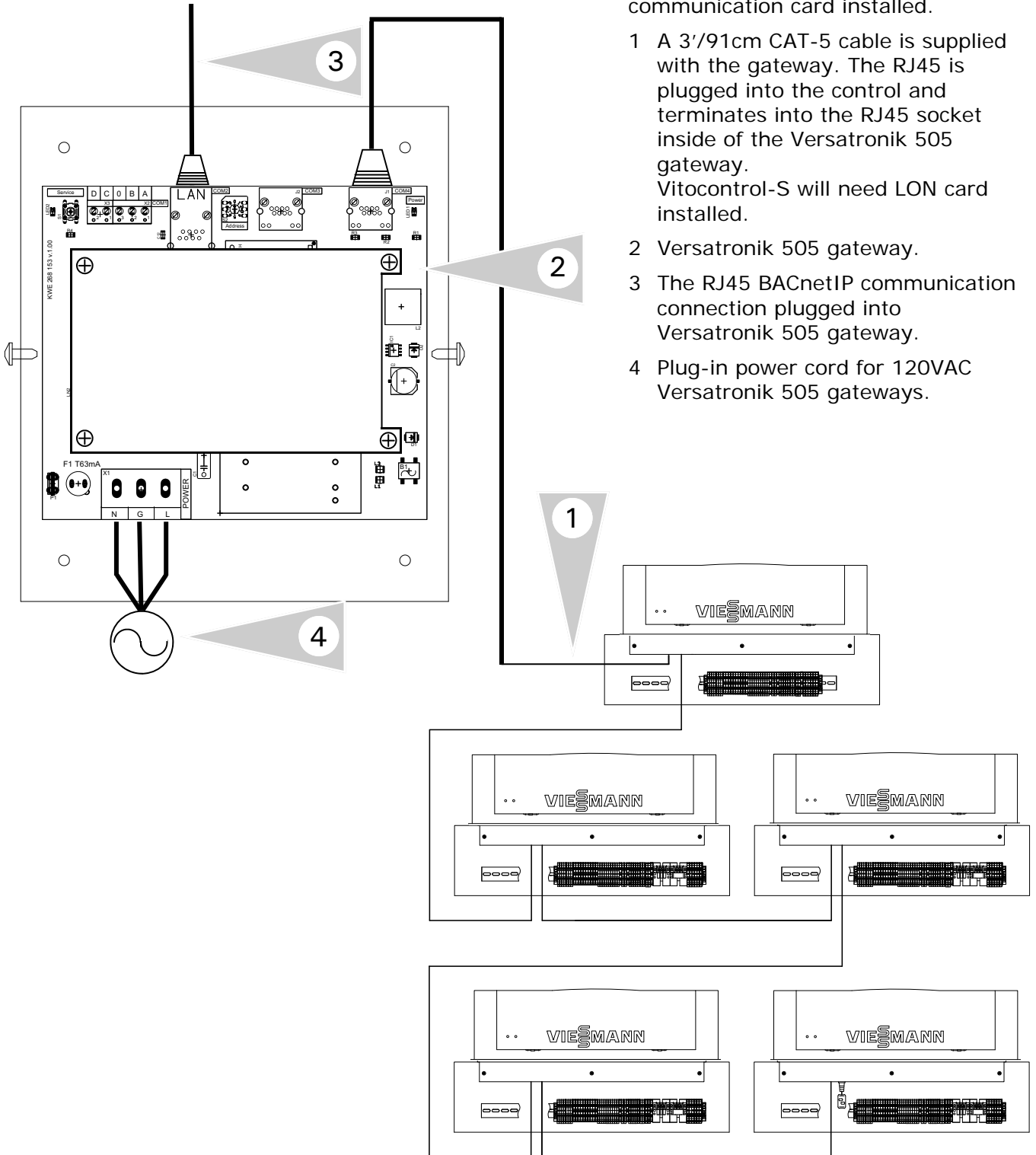

Connection Overview

Refer to manual specific to boiler/
system control. Ensure necessary LON
communication card installed.

- 1 A 3'/91cm CAT-5 cable is supplied with the gateway. The RJ45 is plugged into the control and terminates into the RJ45 socket inside of the Versatronik 505 gateway. Vitocontrol-S will need LON card installed.
- 2 Versatronik 505 gateway.
- 3 The RJ45 BACnetIP communication connection plugged into Versatronik 505 gateway.
- 4 Plug-in power cord for 120VAC Versatronik 505 gateways.

Connection Overview—24VAC

Communication connections—Vitocontrol-S, CT3/VD2A or Vitotronic 300-K MW1B
BACnet IP

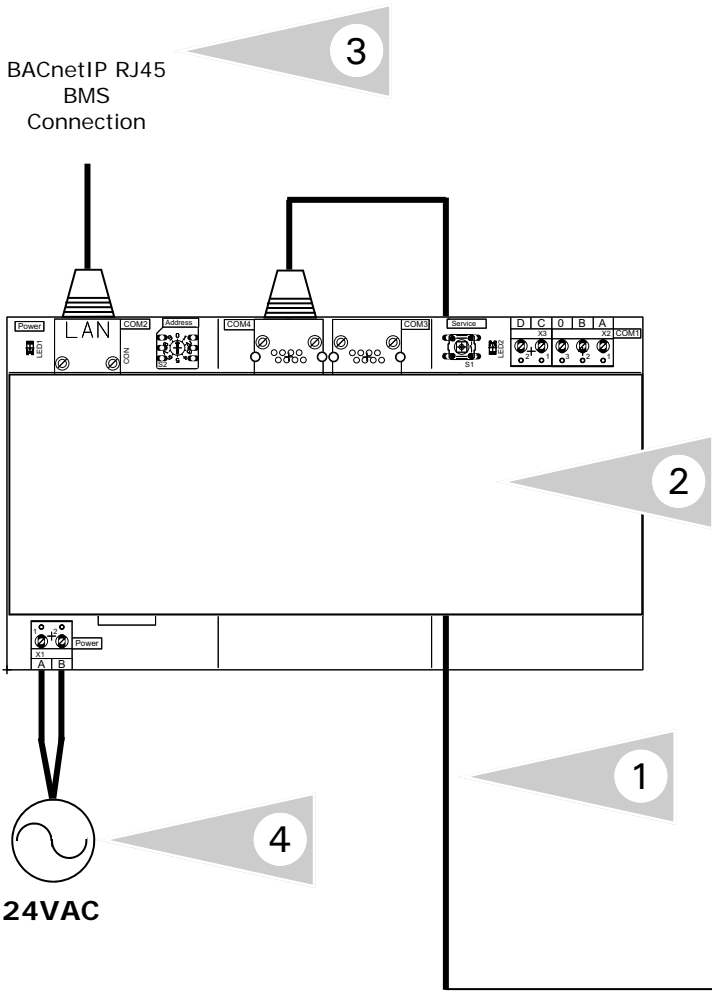

Connection Overview

Refer to manual specific to boiler control. Ensure necessary LON communication card installed.

- 1 A 3' / 91cm CAT-5 cable is supplied with the gateway. The RJ45 is plugged into the control and terminates into the RJ45 socket inside of the Versatronik 505 gateway.
- 2 Versatronik 505 gateway.
- 3 The RJ45 BACnetIP communication connection plugged into Versatronik 505 gateway.
- 4 Field-supplied 24VAC power supply for gateway.

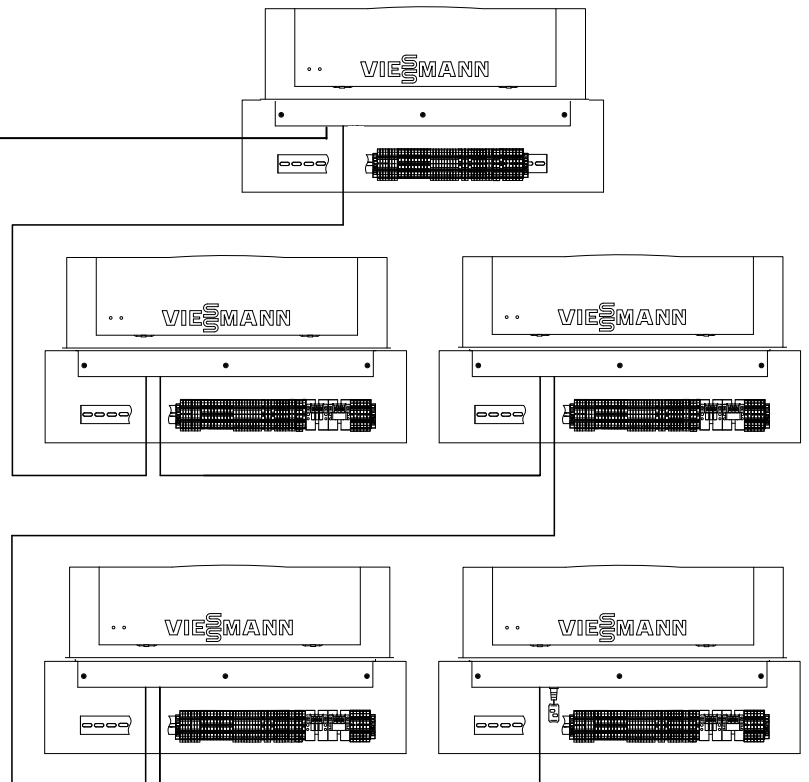

KWE P/N 394038 Versatronik 505 and 505D BACIP Gateway V1.2 February 2014 Technical information subject to change without notice

Connection Overview—120VAC

Communication connections—Vitocontrol-S, MW2 for Vitodens 200, WB2B or Vitotronic 300-K, MW2B BACnet IP

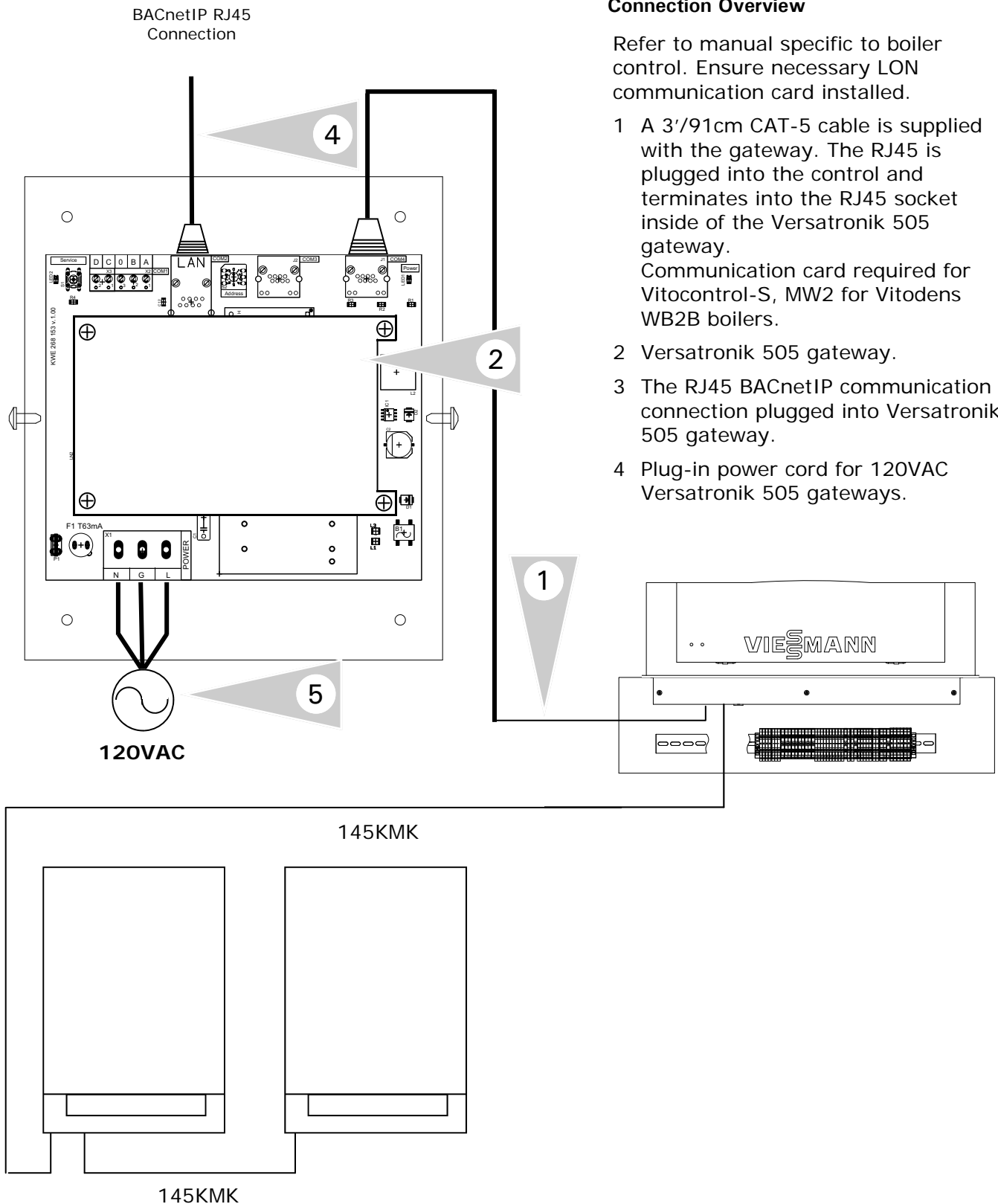

Connection Overview

Refer to manual specific to boiler control. Ensure necessary LON communication card installed.

- 1 A 3'/91cm CAT-5 cable is supplied with the gateway. The RJ45 is plugged into the control and terminates into the RJ45 socket inside of the Versatronik 505 gateway. Communication card required for Vitocontrol-S, MW2 for Vitodens WB2B boilers.
- 2 Versatronik 505 gateway.
- 3 The RJ45 BACnetIP communication connection plugged into Versatronik 505 gateway.
- 4 Plug-in power cord for 120VAC Versatronik 505 gateways.

Connection Overview—120VAC

Communication connections—Vitocontrol-S, MW2 for Vitodens 200, WB2B or Vitotronic 300-K, MW2B BACnet IP

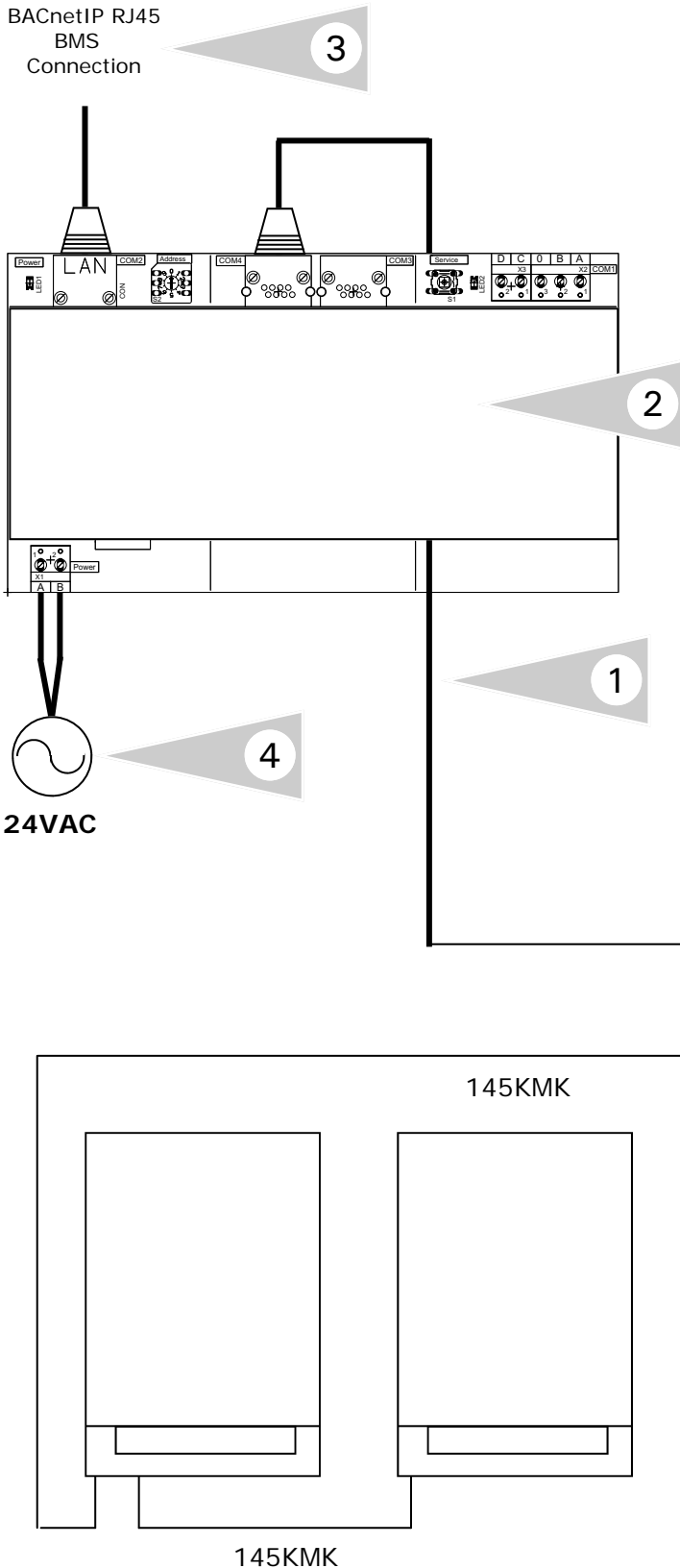

Connection Overview

Refer to manual specific to boiler control. Ensure necessary LON communication card installed.

- 1 A 3/91cm CAT-5 cable is supplied with the gateway. The RJ45 is plugged into the control and terminates into the RJ45 socket inside of the Versatronik 505 gateway.
- 2 Versatronik 505 gateway.
- 3 The RJ45 BACnetIP communication connection plugged into Versatronik 505 gateway.
- 4 Field-supplied 24VAC power supply for gateway.

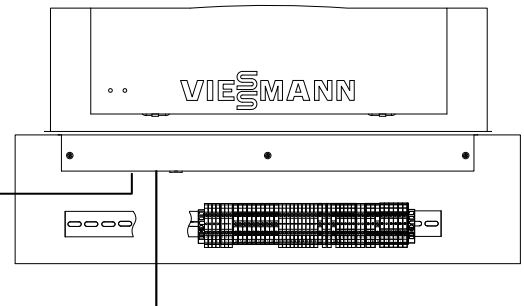

Connection Overview—120VAC

Communication connections—Vitodens 200, WB2B, HO1 and B2HA
BACnet IP

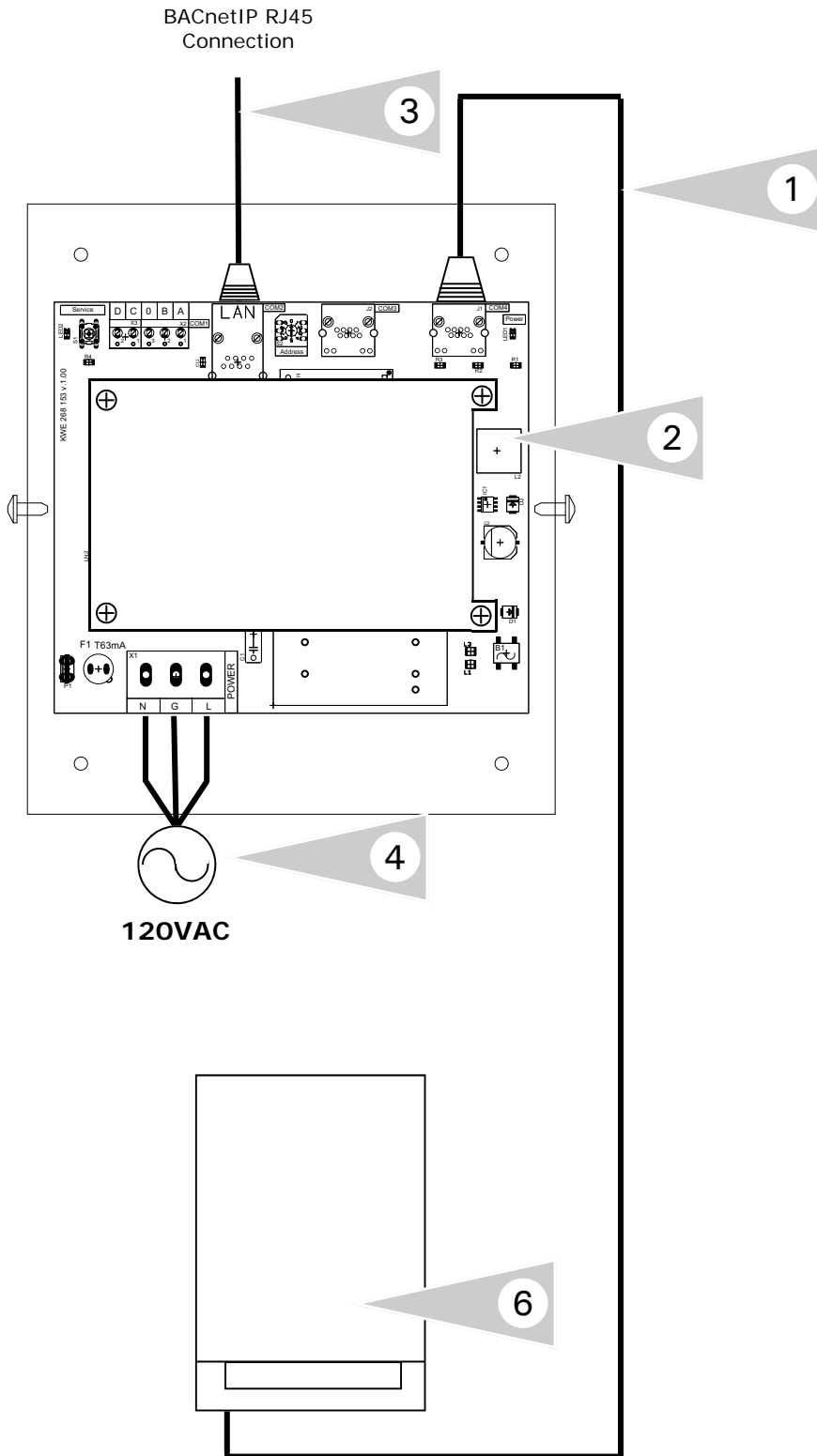

Connection Overview

Refer to manual specific to boiler control. Ensure necessary LON communication card installed.

- 1 A 3' CAT-5 cable is supplied with the gateway. The RJ45 is plugged into the control and terminates into the RJ45 socket inside of the Versatronic 505 gateway.
- 2 Versatronic 505 gateway.
- 3 The RJ45 BACnetIP communication connection plugged into Versatronic 505 gateway.
- 4 Plug-in power cord for 120VAC Versatronic 505 gateways.
- 5 Refer to boiler manual with respect to installing LON communications card inside of boiler control.

Connection Overview—24VAC

Communication connections—Vitodens 200, WB2B, HO1 and B2HA
BACnet IP

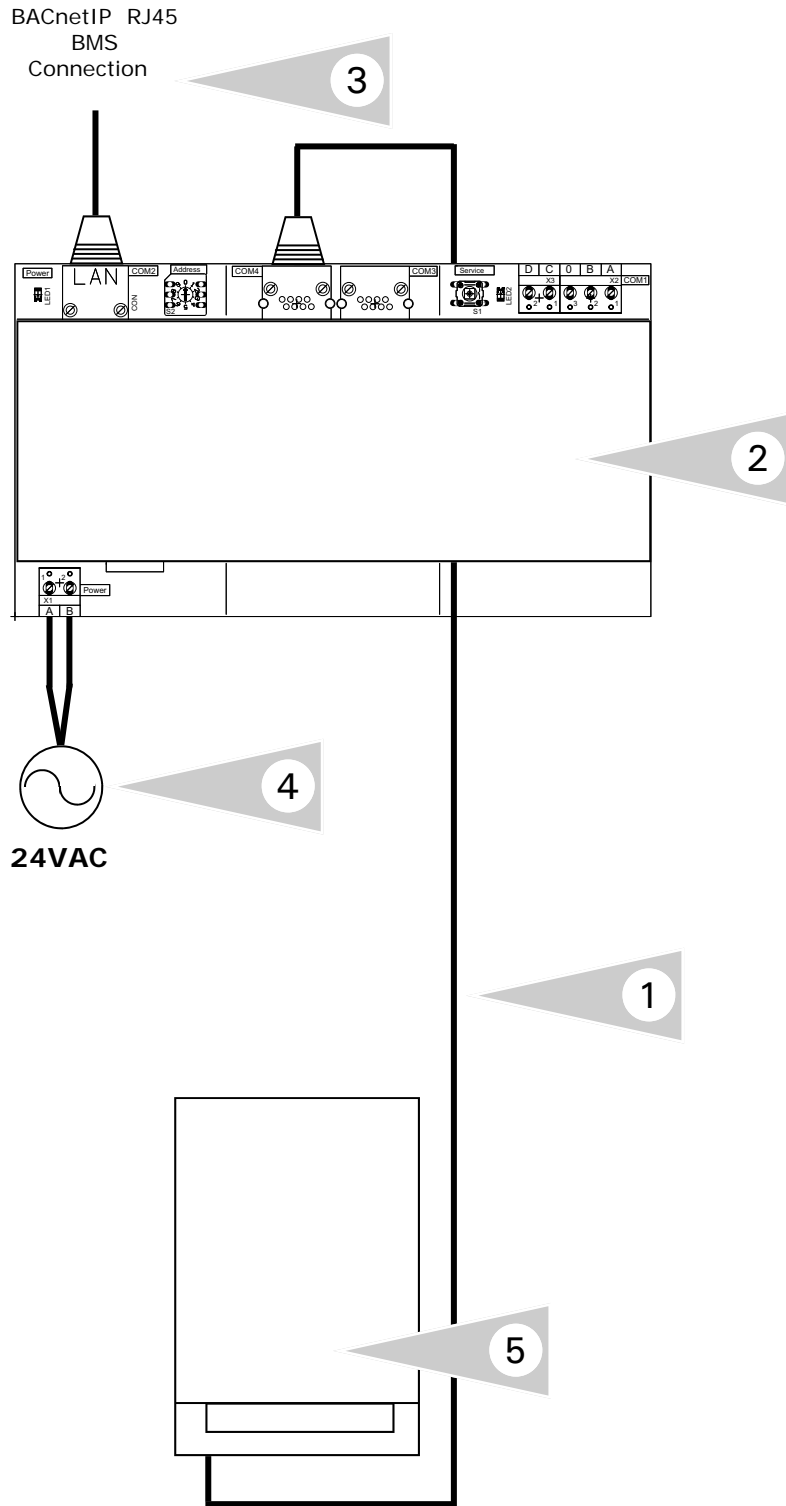

Connection Overview

Refer to manual specific to boiler control. Ensure necessary LON communication card installed.

- 1 A 3'/91cm CAT-5 cable is supplied with the gateway. The RJ45 is plugged into the control and terminates into the RJ45 socket inside of the Versatronik 505 gateway.
- 2 Versatronik 505 gateway.
- 3 The RJ45 BACnetIP communication connection plugged into Versatronik 505 gateway.
- 4 Field-supplied 24VAC power supply for Versatronik gateway.
- 5 Refer to boiler manual with respect to installing LON communications card inside of boiler control.

Update Participant List for Vitocontrol-S, Cascade Control

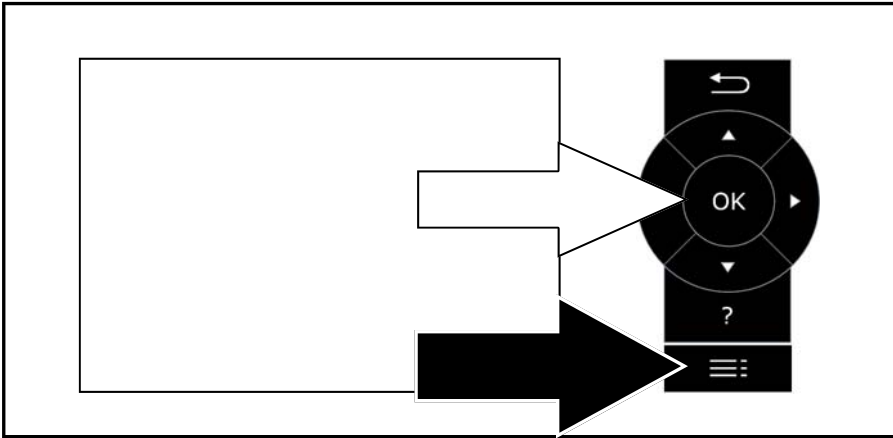

Participant Update

This is to be carried out after all the communication connections have been completed and the Vitocontrol-S, is coded as the error manager.

Requirements:
Vitocontrol-S, must be coded as the error manager (default).
Refer to the Vitocontrol-S manual address 79:01.

The LON participant number must be assigned in each of the Versatronik 505 gateway units. Refer to the rotary dial setting and ensure there are no duplicates.

Press the OK and lined Menu button simultaneously to bring up the **Service** menu option and press **OK**.

Arrow down to **Service Functions** and press **OK**.

When in the **Service Functions** screen, ensure **Subscriber Check** is highlighted. Arrow up or down to highlight if not and press **OK**.

Arrow down to **Delete List?** and press **OK**.

The LON Participant information will be updated as to the boiler controls and any other Versatronik LON devices.

Note:

Re-entering the Subscriber Check too early will result in the screen showing No Subscriber. Continue to wait for some time and then enter the Subscriber Check again. It may take time for all of the devices to report back.

Service
Diagnosis
Actuator
Coding Level 1
Fault History
Service Functions
Terminate Service?



Service Functions
Participant Check
Service PIN



Participant Check
Subscriber 1
Subscriber 3
Subscriber 4
Delete List?



Service
Diagnosis
Actuator
Coding Level 1
Fault History
Service Functions
Terminate Service?

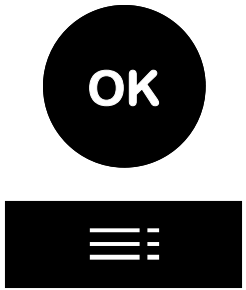

Service Functions
Participant Check
Service PIN



Participant Check
Subscriber 1
Subscriber 3
Subscriber 4
Delete List?



Rotary Switch Position	Participant Value
0	55
1	56
2	57
3	58
4	59
5	60
6	61
7	62

Participant Check

The participant check is used to confirm communication between the boiler controls and the Vitocontrol-S, system control.

Requirements:
 Vitocontrol-S, must be coded as the error manager (default). Refer to the Vitocontrol-S manual address 79:01. The LON participant number must be assigned in each of the Versatronik 505 gateway units. Refer to the rotary dial setting and ensure there are no duplicates.

1. Press the **OK** and **Menu** buttons simultaneously for approximately 2 seconds. This will allow the Service screen to appear.
2. With the arrow down button, select the **Service Functions** menu option.
3. Select **Subscriber Check** if not already highlighted and press **OK**.
4. With the arrow up or down buttons, select a subscriber and press OK. The screen will show the check is active and will report back if it is okay or not.
5. If the check was successful, select a different user by using the arrow up or down buttons. Once selected press OK and repeat the same procedure as outlined in point 4.
6. To exit the subscriber check, press the return button ↵.

Configuration of Gateway

Configuring BACnet/IP Settings

Connect your computer DIRECTLY to the BACnet interface of the gateway device. With no other devices attached (an isolated network). Either set your computer's network connection to automatic IP Address (DHCP), or set your computer's IP address to 192.168.88.90 (subnet mask 255.255.255.0).

Restart the Gateway by cycling the power off and then on again.

Open a browser window and insert the following URL: <http://192.168.88.89/admin>

The default user name/password is "admin" and "admin" (without the quotes). This can be renamed in the Change Password screen. At this point you will see the Configuration pages.

Versatronik 505 NR2/BACIP

- Home
- BACnet/IP Settings**
- BACnet Device Settings
- Advanced Settings
- Restore Defaults
- Change Password
- Activate Configuration

BACnet/IP Settings

This page allows you to view current BACnet/IP settings, to change them or to restore them to factory defaults.

Parameter	Value	Description
IP	<input type="text" value="192.168.0.22"/>	IP address of the BACnet device.
Network Mask	<input type="text" value="255.255.255.0"/>	IP subnet mask.
Default Gateway	<input type="text" value="192.168.0.1"/>	IP address of the default gateway.
UDP Port	<input type="text" value="47808"/>	BACnet/IP UDP port number.

Copyright © 2006-2007 Cimetrics v1.2 (EX-28m-b7092-1.2)

IMPORTANT: Make sure that you remember any changes made here.

Configuration of Gateway Continued

BACnet Device Settings

You can now reconfigure these settings according to your network requirements. Make sure that you press SAVE on every screen where you made changes. The new setting will not take effect until the Activate Configuration screen has been confirmed. These configuration pages can now be accessed through both the 192.168.88.89 Address, as well as the one you have selected.

The BACnet Device Settings screen looks like this:

Versatronik 505 NR2/BACIP

- Home
- BACnet IP Settings
- BACnet Device Settings**
- Advanced Settings
- Restore Defaults
- Change Password
- Activate Configuration

BACnet Device Settings

This page allows you to view current BACnet Device settings, to change them or to restore them to factory defaults.

Parameter	Value	Description
Device ID:	<input type="text" value="1"/>	BACnet Device Instance Number.
Object Name:	<input type="text"/>	Value of the Device's Object_Name property.
Description:	<input type="text"/>	Value of the Device's Device_Description property.
Location:	<input type="text"/>	Value of the Device's Device_Location property.

Copyright © 2006-2007 Cimetrix v1.2 (EX-28m-b7092-1.2)

NOTE: The **Device ID** must be unique on the entire BACnet network.

The Restore Defaults and Change Password screens are very simplistic. When you select Activate Configuration, it will ask you if you want to SAVE your settings. This will then store your new settings and reboot automatically.

You can now join the gateway to the rest of your network, provided you have not specified a duplicate IP Address. Any Computer on the network should now be able to access these configuration screens.

Configuration of Gateway Continued BACnet IP

Analog Output Overview Description

Point	Point Description	Details
AO1	Unit settings	0 = °C, 1 = °F
AO2	Boiler 1 LON Address*	Participant # / Node ID (Address 77) Default 1 -4 for Vitotronic 100 controls Rotary Dial Position for KK10LON and KW10B Add 100 (101 - 104) for KK10LON control Add 200 (201 - 204) for KW10B control
AO3	Boiler 2 LON Address*	
AO4	Boiler 3 LON Address*	
AO5	Boiler 4 LON Address*	
AO6	Zone/Cascade/Boiler LON Address	Participant # of cascade/zone control Default 5 for Vitotronic 300 control Add 200 (205) for MW2 control (for use with WB2B boiler over KMK-BUS)
AO7	Number of Zones on the Zone/Cascade/Boiler	Number of zones on the cascade/zone control. Including the common supply zone (A1). Set 0 if no cascade or 1 through 3 for number of zones.

* If Vitodens communicate via KMK communications with 300-K MW2B cascade control, the value that will need to be entered is 0. Only LON communications with boiler require a LON address. See example below

Configuration of Analog Outputs AO2-AO7

Note: Status Light Operation
Flashing=communication
ON Solid or Off=no communication

System Examples	Analog Output Configuration Settings					
	AO2	AO3	AO4	AO5	AO6	AO7
Single Vitotronic 100, GC1/GC1B Boiler Control	1	0	0	0	1	0
Vitotronic 200, HO1 (Vitodens 200, WB2B)	1	0	0	0	201	2
Vitodens 200 B2HA	1	0	0	0	201	1
Vitotronic 300, GW2 with 2 Mixing Valves	1	0	0	0	1	3
Vitotronic 300, GW5B with 2 Mixing Valves	1	0	0	0	1	3
Vitotronic 300-K, with 2 Vitotronic 100, GC1 (high temp & 1 MV)	1	2	0	0	5	2
Vitotronic 300-K, with 4 Vitotronic 100, GC1 (high temp & 2 MV)	1	2	3	4	5	3
Vitotronic 300-K (Vitodens 200, WB2B/B2HA) Boiler KMK Comm.	0	0	0	0	205	3
Vitotronic 050/200-H, HK1 Mixing Valve Control	0	0	0	0	10	1
Vitotronic 050/200-H, HK3 Mixing Valve Control	0	0	0	0	10	3

Note: Analog output AO7 is a function of AO6. The AO7 setting determines the number of heating circuits of the AO6 control.

The AO2 through to AO6 settings are based on the programmed participant number at address 77 of the boiler controls.

Analog Input Overview

Analog Inputs

Values which can be read from the Versatronik 505 NR2/BACIP Gateway

Note:

Temperature values only possible with specific installed sensors based on particular installation

**Vitodens boilers which communicate via KMK to the 300-K MW2B may not provide some points of information that LON communication does. Boiler/burner faults do not appear directly from the boiler. It is necessary to pick up the burner/boiler fault from the Cascade Fault Status.

Vitotronic 100, GC1	Vitodens 200, B2HA	Vitotronic 200, HO1	Vitotronic 300, GW2	Vitotronic 333/300-K MW1	Vitotronic 300-K, MW2**
---------------------	--------------------	---------------------	---------------------	--------------------------	-------------------------

Point	Point Description	Unit	Points Available Y/N					
AI1	Boiler 1 actual temperature	°C/°F	Y	Y	Y	Y	Y	Y
AI2	Boiler 1 actual return temperature sensor 1 (17A for GC1/GC1B)	°C/°F	Y	N	N	Y	Y	N
AI3	Boiler 1 modulation	°C/°F	Y	N	N	Y	Y	Y
AI4	Boiler 1 flue gas actual temperature	°C/°F	Y	Y	Y	Y	Y	N
AI5	Boiler 1 fault code (Appendix A)	N/A	Y	Y	Y	Y	Y	N
AI6	Boiler 1 relay state (Appendix B)	N/A	Y	Y	Y	Y	Y	N
AI7	Boiler 2 actual temperature	°C/°F	N	N	N	N	Y	Y
AI8	Boiler 2 actual return temperature sensor 1 (17A for GC1/GC1B)	°C/°F	N	N	N	N	Y	N
AI9	Boiler 2 modulation	°C/°F	N	N	N	N	Y	Y
AI10	Boiler 2 flue gas actual temperature	°C/°F	N	N	N	N	Y	N
AI11	Boiler 2 fault code (Appendix A)	N/A	N	N	N	N	Y	N
AI12	Boiler 2 relay state (Appendix B)	N/A	N	N	N	N	Y	N
AI13	Boiler 3 actual temperature	°C/°F	N	N	N	N	Y	Y
AI14	Boiler 3 actual return temperature sensor 1 (17A for GC1/GC1B)	°C/°F	N	N	N	N	Y	N
AI15	Boiler 3 modulation	°C/°F	N	N	N	N	Y	Y
AI16	Boiler 3 flue gas actual temperature	°C/°F	N	N	N	N	Y	N
AI17	Boiler 3 fault code (Appendix A)	N/A	N	N	N	N	Y	N
AI18	Boiler 3 relay state (Appendix B)	N/A	N	N	N	N	Y	N
AI19	Boiler 4 actual temperature	°C/°F	N	N	N	N	Y	Y
AI20	Boiler 4 actual return temperature sensor 1 (17A for GC1/GC1B)	°C/°F	N	N	N	N	Y	N
AI21	Boiler 4 modulation	°C/°F	N	N	N	N	Y	Y
AI22	Boiler 4 flue gas actual temperature	°C/°F	N	N	N	N	Y	N
AI23	Boiler 4 fault code (Appendix A)	N/A	N	N	N	N	Y	N
AI24	Boiler 4 relay state (Appendix B)	N/A	N	N	N	N	Y	N
AI25	Zone/Cascade/Boiler Outdoor temperature	°C/°F	N	Y	Y	Y	Y	Y
AI26	Zone/Cascade/Boiler Relay State (Appendix B)	N/A	N	Y	Y	Y	Y	Y
AI27	Zone/Cascade/Boiler Fault Code (Appendix A)	N/A	N	Y	Y	Y	Y	Y
AI28	Zone/Cascade/Boiler DHW Set-Point	°C/°F	Y	Y	Y	Y	Y	Y
AI29	Zone/Cascade/Boiler DHW Actual Temperature	°C/°F	Y	Y	Y	Y	Y	Y
AI30	Zone/Cascade/Boiler Zone A1 Supply Set-Point	°C/°F	Y	Y	Y	Y	Y	Y
AI31	Zone/Cascade/Boiler Zone A1 Supply Actual Temperature	°C/°F	N	Y	Y	Y	Y	Y
AI32	Zone/Cascade/Boiler Zone A1 Actual Return Temperature	°C/°F	N	N	N	Y	Y	Y
AI33	Zone/Cascade/Boiler Zone A1 Curve Shift	°K	N	Y	Y	Y	Y	Y
AI34	Zone/Cascade/Boiler Zone A1 Curve Slope	N/A	N	Y	Y	Y	Y	Y

KWE P/N 394038 Versatronik 505 and 505D BACIP Gateway V1.2 February 2014 Technical information subject to change without notice

Analog Input Overview Continued

Analog Inputs Continued

Values which can be read from the Versatronik 505 NR2/BACIP Gateway

Note:

Temperature values only possible with specific installed sensors based on particular installation.

Vitotronic 100, GC1	Vitodens 200, B2HA	Vitotronic 200, HO1	Vitotronic 300, GW2	Vitotronic 333/300-K MW1	Vitotronic 300-K, MW2
---------------------	--------------------	---------------------	---------------------	--------------------------	-----------------------

Point	Point Description	Unit	Points Available Y/N					
AI35	Zone/Cascade/Boiler Zone A1 Curve Room Temp. Normal	°C/°F	N	Y	Y	Y	Y	Y
AI36	Zone/Cascade/Boiler Zone A1 Curve Room Temp. Reduce	°C/°F	N	Y	Y	Y	Y	Y
AI37	Zone/Cascade/Boiler Zone M2 Supply Set-Point	°C/°F	N	Y	Y	Y	Y	Y
AI38	Zone/Cascade/Boiler Zone M2 Supply Actual Temperature	°C/°F	N	Y	Y	Y	Y	Y
AI39	Zone/Cascade/Boiler Zone M2 Curve Shift	°K	N	Y	Y	Y	Y	Y
AI40	Zone/Cascade/Boiler Zone M2 Curve Slope	N/A	N	Y	Y	Y	Y	Y
AI41	Zone/Cascade/Boiler Zone M2 Curve Room Temp. Normal	°C/°F	N	Y	Y	Y	Y	Y
AI42	Zone/Cascade/Boiler Zone M2 Curve Room Temp. Reduce	°C/°F	N	Y	Y	Y	Y	Y
AI43	Zone/Cascade/Boiler Zone M3 Supply Set-Point	°C/°F	N	N	N	Y	Y	Y
AI44	Zone/Cascade/Boiler Zone M3 Supply Actual Temperature	°C/°F	N	N	N	Y	Y	Y
AI45	Zone/Cascade/Boiler Zone M3 Curve Shift	°K	N	N	N	Y	Y	Y
AI46	Zone/Cascade/Boiler Zone M3 Curve Slope	N/A	N	N	N	Y	Y	Y
AI47	Zone/Cascade/Boiler Zone M3 Curve Room Temp. Normal	°C/°F	N	N	N	Y	Y	Y
AI48	Zone/Cascade/Boiler Zone M3 Curve Room Temp. Reduce	°C/°F	N	N	N	Y	Y	Y

Multi-state Burner Information—All Boiler Controls

Point	Point Description	Unit
MI1	Boiler 1 Burner State	*See table below
MI2	Boiler 2 Burner State	*See table below
MI3	Boiler 3 Burner State	*See table below
MI4	Boiler 4 Burner Stage	*See table below

State	Value	State	Value	State	Value
1	Off	5	30%	9	70%
2	Fault	6	40%	10	80%
3	10%	7	50%	11	90%
4	20%	8	60%	12	100%

Note: The burner percentage is only a control approximation and does not reflect the actual position. Consult with burner manual or manufacturer for signal output from burner

Analog Outputs Overview

Analog Outputs

Values which can be “written” to the Versatronik 505 NR2/BACIP Gateway

Note:

Temperature values only possible with specific installed sensors based on particular installation.

Point	Point Description	Unit	Points Available Y/N					
			Vitotronic 100, GC1	Vitodens 200, B2HA	Vitotronic 200, HO1	Vitotronic 300, GW2	Vitotronic 333/300-K MW1	Vitotronic 300-K, MW2
AO1	Unit settings – 0 = °C, 1 = °F	N/A	Y	Y	Y	Y	Y	Y
AO2	Boiler 1 LON Address (Configured Value must be set during commissioning)	N/A	Y	Y	Y	Y	N	N
AO3	Boiler 2 LON Address (Configured Value must be set during commissioning)	N/A	Y	Y	Y	Y	N	N
AO4	Boiler 3 LON Address (Configured Value must be set during commissioning)	N/A	Y	Y	Y	Y	N	N
AO5	Boiler 4 LON Address (Configured Value must be set during commissioning)	N/A	Y	Y	Y	Y	N	N
AO6	Zone/Cascade/Boiler LON Address (Configured Value must be set during commissioning)	N/A	N	Y	Y	Y	Y	Y
AO7	Number of Zones on the Zone/Cascade/Boiler (Configured Value must be set during commissioning)	N/A	N	Y	Y	Y	Y	Y
AO8	Zone/Cascade/Boiler DHW Writeable Set-Point	°C/°F	Y	Y	Y	Y	Y	Y
AO9	Zone/Cascade/Boiler Zone A1 Writeable Curve Shift	°K	N	Y	Y	Y	Y	Y
AO10	Zone/Cascade/Boiler Zone A1 Writeable Curve Slope	N/A	N	Y	Y	Y	Y	Y
AO11	Zone/Cascade/Boiler Zone A1 Writeable Curve Room Temp. Normal	°C/°F	N	Y	Y	Y	Y	Y
AO12	Zone/Cascade/Boiler Zone A1 Writeable Curve Room Temp. Reduce	°C/°F	N	Y	Y	Y	Y	Y
AO13	Zone/Cascade/Boiler Zone A1 Writeable Supply Set-Point	°C/°F	N	Y	Y	Y	Y	Y
AO14	Zone/Cascade/Boiler Zone M2 Writeable Curve Shift	°K	N	Y	Y	Y	Y	Y
AO15	Zone/Cascade/Boiler Zone M2 Writeable Curve Slope	N/A	N	Y	Y	Y	Y	Y
AO16	Zone/Cascade/Boiler Zone M2 Writeable Curve Room Temp. Normal	°C/°F	N	Y	Y	Y	Y	Y
AO17	Zone/Cascade/Boiler Zone M2 Writeable Curve Room Temp. Reduce	°C/°F	N	Y	Y	Y	Y	Y
AO18	Zone/Cascade/Boiler Zone M2 Writeable Supply Set-Point	°C/°F	N	Y	Y	Y	Y	Y
AO19	Zone/Cascade/Boiler Zone M3 Writeable Curve Shift	°K	N	N	N	Y	Y	Y
AO20	Zone/Cascade/Boiler Zone M3 Writeable Curve Slope	N/A	N	N	N	Y	Y	Y
AO21	Zone/Cascade/Boiler Zone M3 Writeable Curve Room Temp. Normal	°C/°F	N	N	N	Y	Y	Y
AO22	Zone/Cascade/Boiler Zone M3 Writeable Curve Room Temp. Reduce	°C/°F	N	N	N	Y	Y	Y
AO23	Zone/Cascade/Boiler Zone M3 Writeable Supply Set-Point	°C/°F	N	N	N	Y	Y	Y

Fault Codes

Appendix A—Fault Codes

Error codes for Viessmann control units based on controls/equipment installed

Fault Code (hex)	Fault Code (Dec)	Description
00	00	System without fault
0F	15	Perform maintenance check-up
10	16	Short circuit, outdoor temperature sensor
18	24	Interruption, outdoor temperature sensor
20	32	Short circuit, supply temperature sensor HC1/system
28	40	Interruption, supply temperature sensor HC1/system
30	48	Short circuit, boiler water temperature sensor
38	56	Interruption, boiler water temperature sensor
40	64	Short circuit, supply temperature sensor heating circuit 2
41	65	Short circuit, return temperature sensor heating circuit 2
44	68	Short circuit, supply temperature sensor heating circuit 3
45	69	Short circuit, return temperature sensor heating circuit 3
48	72	Interruption, supply temperature sensor heating circuit 2
49	73	Interruption, return temperature sensor heating circuit 2
4C	76	Interruption, supply temperature sensor heating circuit 3
4d	77	Interruption, return temperature sensor heating circuit 3
50	80	Short circuit, DHW tank temperature sensor
51	81	Short circuit, DHW tank temperature sensor 2
58	88	Interruption, DHW tank temperature sensor
59	89	Interruption, DHW tank temperature sensor 2
60	96	Short circuit, return temperature sensor 17
68	104	Interruption, return temperature sensor 17
70	112	Short circuit, supply/return temperature sensor 17B
78	120	Interruption, supply/return temperature sensor 17B
92	146	Solar: collector temperature short circuit
93	147	Solar: collector return temperature short circuit
94	148	Solar: collector DHW tank temperature sensor short circuit
9A	154	Solar: collector temperature sensor open circuit
9B	155	Solar collector return temperature sensor open circuit
9C	156	Solar: DHW tank temperature sensor open circuit
9F	159	Solar: general fault message
A7	167	Fault control unit wireless clock module
AE	174	Internal fault mixing valve
AF	175	Internal fault mixing valve
b0	176	Short circuit, flue gas temperature sensor
b1	177	Communication fault, programming unit (internal)
b4	180	Internal fault
b5	181	Internal fault
b6	182	Internal fault, invalid hardware recognition
b7	183	Internal fault, boiler protection coding card
b8	184	Interruption, flue gas temperature sensor
bA	186	Fault, mixing valve module (KM-BUS)
bC	188	Fault, Vitotrol heating circuit 1 (KM-BUS)
bd	186	Fault, Vitotrol heating circuit 2 (KM-BUS)
bE	190	Fault, Vitotrol heating circuit 3 (KM-BUS)
C1	193	External fault indication, boiler
C2	194	Communication fault solar control unit (KM-BUS)

Fault Codes Continued

Appendix A—Fault Codes Continued

Error codes for Viessmann control units based on controls/equipment installed

Fault Code (hex)	Fault Code (Dec)	Description
C5	197	Fault, speed controlled pump heating circuit 1 (KM-BUS)
C6	198	Fault, speed controlled pump heating circuit 2 (KM-BUS)
C7	199	Fault, speed controlled pump heating circuit 3 (KM-BUS)
C8	200	Fault, water level control
C9	201	Fault, maximum pressure
CA	202	Fault, minimum pressure/maximum pressure 2
Cb	203	Fault, maximum pressure 2
CC	204	Reserved, external periphery
Cd	205	Communication fault, Vitocom 300 (KM-BUS)
CE	206	Communication fault, fault indicator module (KM-BUS)
CF	207	Communication fault: wrong LON module
d1	209	Burner fault, boiler
d4	212	Fixed high limit fault, boiler
d5	213	Cascade: boiler is not responding
d6	214	External fault 1, plug-in adaptor
d7	215	External fault 2, plug-in adaptor
d8	216	External fault 3, plug-in adaptor
dA	218	Short circuit, room temperature sensor heating circuit 1
db	219	Short circuit, room temperature sensor heating circuit 2
dC	220	Short circuit, room temperature sensor heating circuit 3
dd	221	Interruption, room temperature sensor heating circuit 1
dE	222	Interruption, room temperature sensor heating circuit 2
dF	223	Interruption, room temperature sensor heating circuit 3
E0	224	Fault, external participant/device connected to LON
E4	228	Fault power supply voltage
E5	229	Internal fault combustion control unit
E6	230	Flue gas/air supply system blocked
F0	240	Communication fault combustion control unit
F1	241	Flue gas temperature limit has tripped
F2	242	Temperature limit has tripped
F3	243	Flame signal is present at burner start
F4	244	Flame signal is not present
F5	245	Air pressure switch not open for burner start
F6	246	Gas pressure switch not open for burner start
F7	247	Air pressure sensor short circuit or offset value outside of tolerances
F8	248	Fuel valve closure delayed
F9	249	Blower speed too low at burner start
FA	250	Blower speed too high at burner start
FC	252	Control of modulation valve defective
FD	253	Fault combustion control unit
FE	254	Coding plug defective or wrong EMV error
FF	255	Internal fault

Additional Alarm/Fault Information

Viessmann controls show fault codes in hexadecimal format to conserve screen space on the user interface of the boiler and system controls. The Versatronik 505 gateway uses a SNVT_count variable which is usually displayed in decimal format.

The base-format in which this fault can be displayed depends on your BMS software. This example shows how to display this fault code in hexadecimal, and Text format in Niagara AX.

To display in hex, you can use the KitControl -> Util "Numeric Bit And" object's mask input.

To display the equivalent fault text value, you can use the KitControl -> Conversion "Numeric To Enum" object and type out the enum range for all Viessmann error codes.

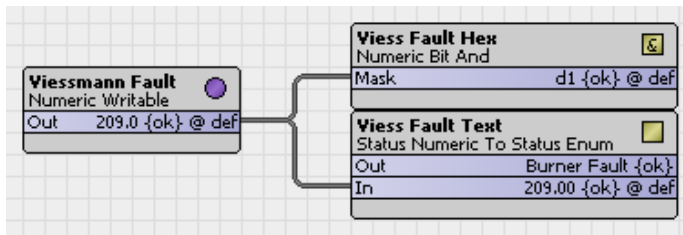

These values can now be displayed on a px webpage by pointing a Bound Label to the appropriate slot values.

Fault Code: d1 (Burner Fault)

Status Information

Appendix B—Status Information

x = always available for this device

k = dependent on configuration of device

n = not available for this device

Bit	Relay State								
		Vitotronic 100, GC1/GC1B	Vitotronic 300, GW2/GW5B	Vitotronic 333/300-K MW1	Vitotronic 050/200H HK1M	Vitotronic 050 HK1 Panel	Vitotronic 050 HK3 Panel	Vitotronic 300-K, MW1B, MW2B	Vitotronic 200, HO1/Vitodens B2HA
0	bit 2 ⁰ : DHW tank loading pump	k	k	k	n	k	k	k	k
1	bit 2 ¹ : Re-circulation pump	n	k	k	n	k	k	k	k
2	bit 2 ² : Heating circuit pump 1	n	k	k	x	x	k	k	x
3	bit 2 ³ : Heating circuit pump 2	n	k	k	n	n	k	k	k
4	bit 2 ⁴ : Heating circuit pump 3	n	k	k	n	n	k	k	n
5	bit 2 ⁵ : Night-time contact HKP 1	n	k	k	x	x	k	k	x
6	bit 2 ⁶ : Night-time contact HKP 2	n	k	k	n	n	k	k	k
7	bit 2 ⁷ : Night-time contact HKP 3	n	k	k	n	n	k	k	n
8	bit 2 ⁸ : Supply pump	n	n	n	k	k	k	n	n
9	bit 2 ⁹ : Primary pump heat exchanger set for DHW tank loading	k	k	k	n	k	k	k	n
	bit 2 ⁹ : DHW tank pump	n	n	n	n	n	n	n	k
10	bit 2 ¹⁰ : Boiler circuit and distribution (common supply) pump	k	k	k	n	n	n	n	k
	bit 2 ¹⁰ : Internal Pump	n	n	n	n	n	n	k	x
11	bit 2 ¹¹ : Shunt pump	k	k	k	n	n	n	n	n
	bit 2 ¹¹ : Diverting valve in space heating position	n	n	n	n	n	n	n	k
12	bit 2 ¹² : Flue gas heat exchanger pump	x	n	n	n	n	n	n	n
13	bit 2 ¹³ : ThermControl switching contact	k	n	n	n	n	n	n	n
	bit 2 ¹³ : Diverting valve in DHW position	n	n	n	n	n	n	n	k
14	bit 2 ¹⁴ : Burner 1 st stage	x	x	n	n	n	n	n	n
15	bit 2 ¹⁵ : Burner fault	x	x	n	n	n	n	n	n
	bit 2 ¹⁵ : Compiled fault	n	n	n	n	n	n	n	x

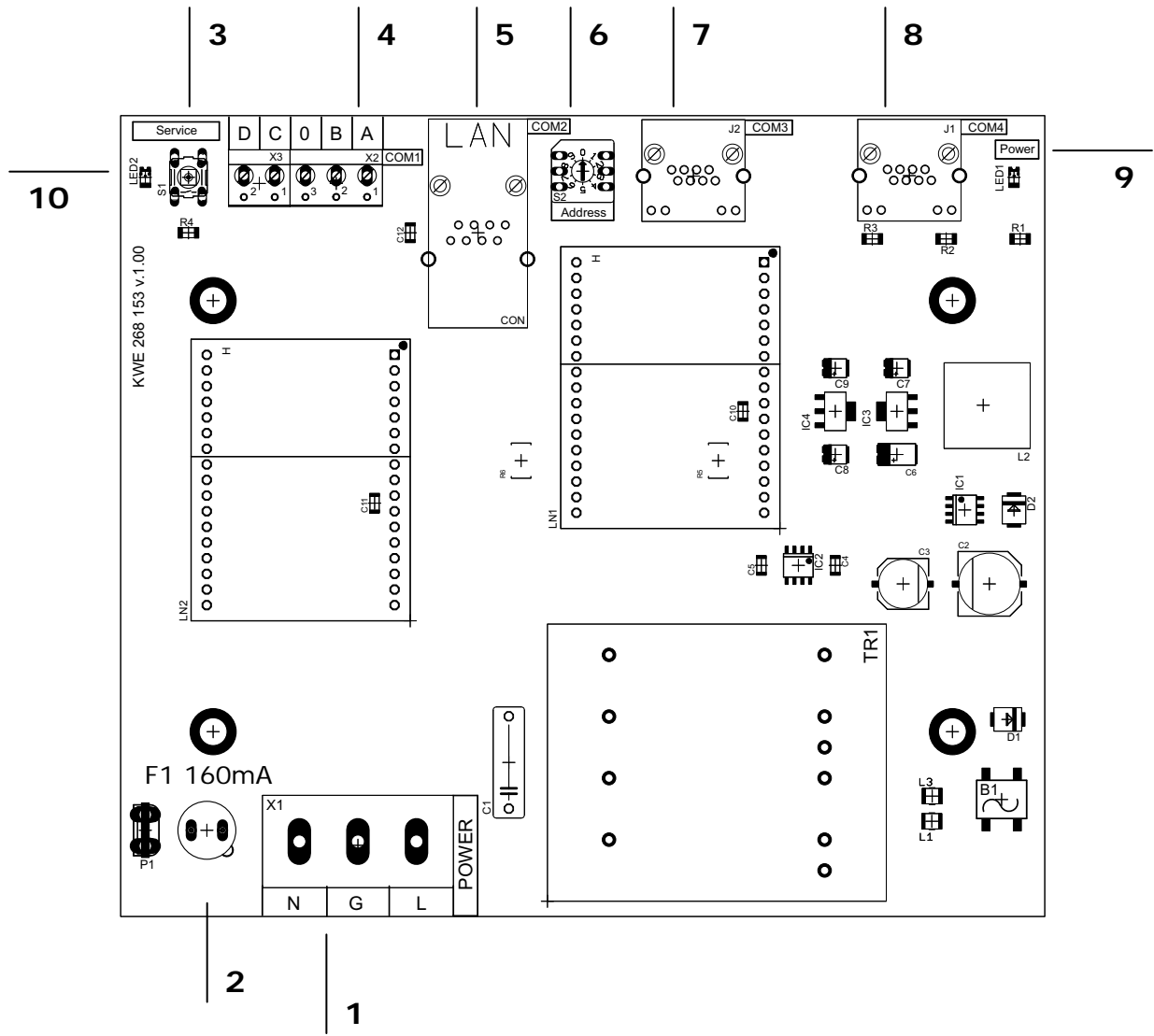

PCB Identifiers

1	120VAC Power Supply Connections
2	Fuse
3	Service Button
4	LON Connections to BMS
5	RJ45 Connection to BMS BACnet
6	Addressing selector for multiple modules
7	COM3 for multiple BUS connections
8	COM4 RJ45 Connection to control
9	Power LED indicator
10	Service LED

Specifications

Voltage Requirements	120VAC
Fuse Rating	160mA Time Delay
Power	4VA
Communication Connections	Supplied cable between devices

CAUTION

Static sensitive components may be damaged by improper handling or work within the control. Ensure all possible measures are taken to eliminate build-up of static electricity.

Technical Information

KWE P/N 394038 Versatronik 505 and 505D BACIP Gateway V1.2 February 2014 Technical information subject to change without notice

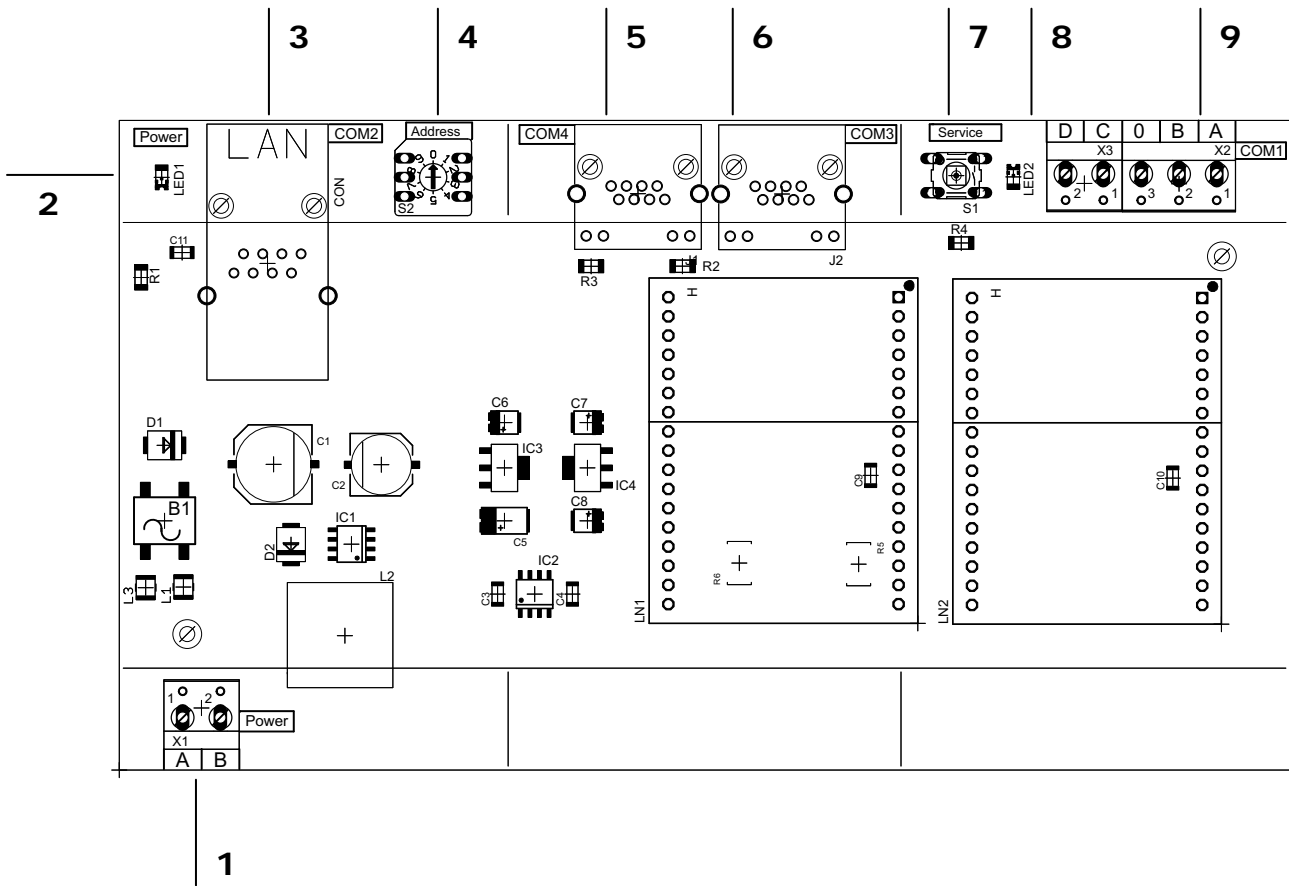

PCB Identifiers

1	24VAC Power Supply Connections
2	Power LED indicator
3	BACnet RJ45 BMS Connection
4	Addressing dial for multiple units
5	COM4 RJ45 Connection to control
6	COM3 for multiple BUS connections
7	Service button
8	Service LED
9	LON Connections to BMS

Specifications

Voltage Requirements	24VAC
Fuse Rating	N/A
Power	4VA
Communication Connections	Supplied cable between devices



CAUTION

Static sensitive components may be damaged by improper handling or work within the control. Ensure all possible measures are taken to eliminate build-up of static electricity.

KWE Technologies Group
750 McMurray Road
Waterloo, Ontario, Canada
N2V 2G5
Tel: (519) 747-5042
Fax: (519) 747-4448
www.kwe-tech.com
info@kwe-tech.com

